



EN



**Operation
manual**

Flaring
device DN 25





KROHSE GmbH
Gewerbestrasse 2
CH-8212 Neuhausen am Rheinflall
SWITZERLAND



+41 (0) 52 202 10 51



info@krohse.ch



www.krohse.ch

© 2020 KROHSE GmbH

The reproduction, distribution and utilisation of this document as well as the communication of its contents to others without express authorisation is prohibited. Offenders will be held liable for the payment of damages. All rights reserved in the event of the grant of a patent, utility model or design (ISO 16016).

The right to make technical changes is reserved. Misprints and printing errors excepted. The data provided are guide values and shall not, in the legal sense, be construed as guaranteed properties. Values could vary as a result of component tolerances.

Version: 03-2024



Table of contents

1	Function and operating principle.....	4
2	Technical specification	5
3	System components.....	6
4	Safety and responsibility.....	9
4.1	Warning signs	9
4.2	Signs and symbols	9
4.3	Intended use	10
4.4	Improper use.....	10
4.5	Product safety with factory test report	11
4.6	Manufacturer's declaration	12
4.7	Guarantee	13
4.8	General terms and conditions of business.....	13
5	Scope of delivery.....	14
6	Assembling the flaring device	15
6.1	Tools for assembly/disassembly.....	15
6.2	Prerequisites for setting up the flaring device	15
6.3	Assembly and set-up.....	16
7	Preparations for safe operation	20
8	Commissioning.....	21
8.1	Function and leak testing before commissioning	21
8.2	Without Venturi nozzle (STANDARD).....	22
8.3	With Venturi nozzle (PRO)	24
8.4	Explosive concentrations.....	27
9	Disassembling the flaring device	28
9.1	Tools for disassembly.....	28
9.2	Disassembly and removal	28
10	Troubleshooting	31
10.1	Fault causes and remedial measures	31
10.2	Technical support.....	32
11	Storage and transport.....	32
12	Maintenance and repair.....	33
12.1	Cleaning and care	33
12.2	Maintenance	33
12.3	Wear of components	34
12.4	Cleaning/replacing the prefilter	35
13	Accessories.....	36
14	Disposal	37
15	Appendix	38
15.1	Data sheet: Flame flashback/gas backflow arrester	38
15.2	DVGW certificate: Valves	40
16	Usage record.....	47



Foreword

Dear Customer,

Thank you for your purchase. With this flaring device, you have chosen a high-quality and easy-to-handle product. To ensure that you can work reliably and safely with this device for years to come, we would like to draw your attention to the user information presented in this manual. KROHSE GmbH has made every effort to manufacture a safe and robust product conforming to all applicable laws and regulations. Strict pre-delivery quality checks undertaken in our factory are key to maintaining our high quality standards. Please continue to maintain our standards by treating the device with care. If you have any questions on how to use the device, please contact us at any time.

We wish you every success and hope that you enjoy working safely on your supply line.

Thomas Krohse
KROHSE GmbH

1 Function and operating principle



A flaring device is designed to burn off residual gases in a controlled manner so that they do not enter the atmosphere and form ignitable mixtures or contribute to environmental pollution. In principle, the flaring device can be used for two different applications:

a) **Degassing** (emptying a gasline/container/system)

During gas line repair work, the line must be free of gas for safety reasons. After the gas supply has been shut off (e.g. by inflatable stoppers), the residual gas remaining in the line is safely tapped, withdrawn and combusted in a controlled manner using a flaring device.

b) **Gassing** (filling a gas line/container/system)

When a gas line is being put into service, it is necessary to purge the pipe section of all air by the controlled introduction of gas. This means replacing the air in the line with gas. Until the line has been completely filled, an explosive gas-air mixture is released. This is drawn away and combusted in a safe and controlled manner by the flaring device.



2 Technical specification



The flaring device is suitable for use under the following conditions:

- Pressure range: 5 mbar to 5 bar
- Temperature range: -20 °C to +70 °C
- Volumetric flow: See charts (Figure 4: and Figure 5: on page 8)

Technical data:

- Total height (in ready-to-use condition)
ECO & PREMIUM: 2140 mm/ PREMIUM-PRO: 2230 mm
- Manufactured from stainless steel 1.4301 DN 25 (1"), glass-bead blasted
- Flame flashback/gas backflow arrester (DVGW-certified)
- With integrated prefilter mesh size 0.1 mm (fitted to the main pipe)
- Degassing hose GWPB DN 19 x 4.5 mm for propane/natural gas, PN 20, ISO 3821

Transport trolley dimensions

L x W x H: 1199 mm x 419 mm x 234 mm

Weight: 15 kg flaring device + 15 kg transport trolley including accessories

Variants

The variants of the KROHSE GmbH flaring device differ in the material used for the flame flashback/gas backflow arrester (brass or stainless steel) and in their operation with or without a Venturi nozzle (for evacuating the line).



	Brass	Stainless steel
without venturi nozzle	<p>ECO-Standard</p> <p>Artikel-Nr.: 9020000</p> 	<p>PREMIUM-Standard</p> <p>Artikel-Nr.: 9020005</p> 
with venturi nozzle	<p>PREMIUM-PRO</p> <p>Artikel-Nr.: 9020015</p> 	

Table 1: Overview of flaring device variants



3 System components



The system components are designed for use in the gas supply and have the specifications described below.



Figure 1: *Transport trolley*

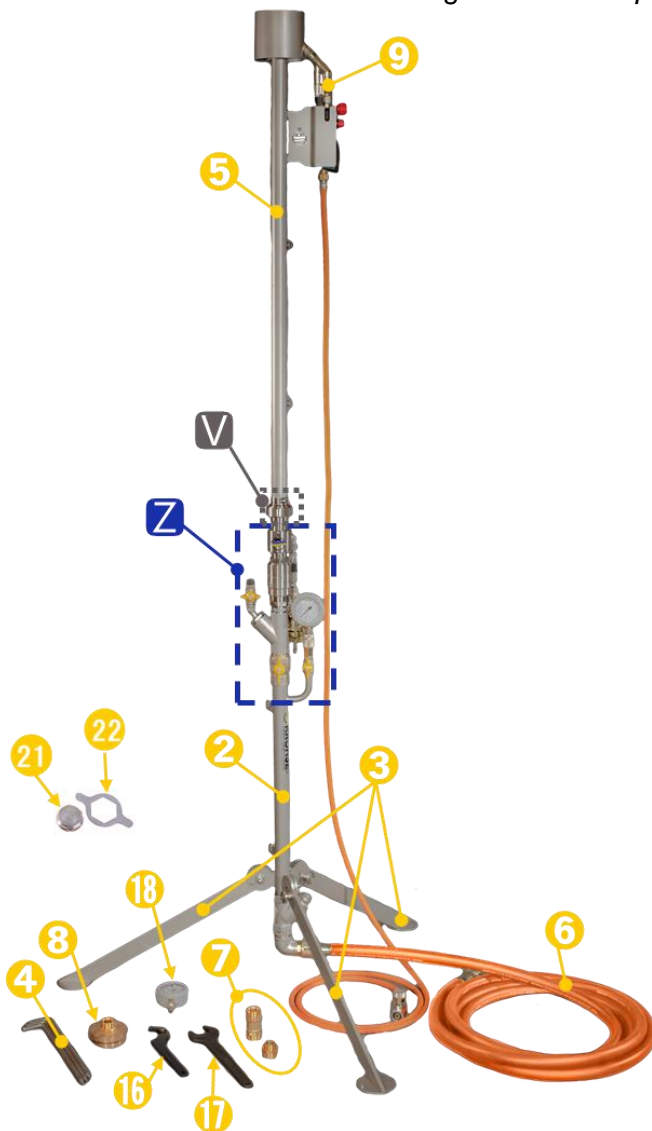

Figure 2: *System components*

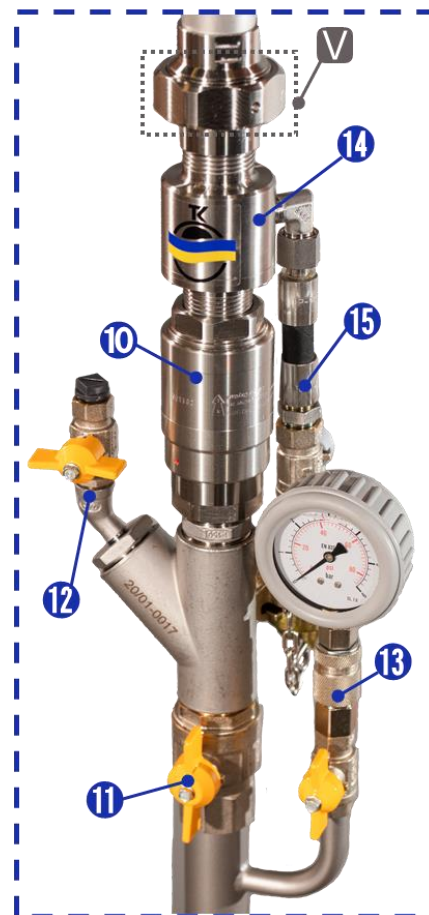

Figure 3: *Main valve unit*



	Component	Item no.	Specification
1	Transport trolley	9050000	HPX
2	Lower riser module with main valve unit (Z) and folding feet (3)		Stainless steel 1.4301
4	Ground pegs (2 pcs)	1420005	Stainless steel 1.4301
	Ground peg with cable socket (1 pc)	1420045	Stainless steel 1.4301
5	Upper riser		Stainless steel 1.4301
6	Degassing hose set	8050090	GWPB DN 19 x 4.5 mm for propane/natural gas, PN 20, ISO 3821 (free choice of length) with brass coupler at both ends (female taper G1" ET)
7	Coupler for degassing hose 1" ET x 1" ET (1 pc)	1460085	Brass, both ends Female taper with G1" ET
8	Connection adapter <ul style="list-style-type: none"> • 2 ½" ET (1 pc) • ¾" ET (2 pcs) 	1460040 7370232	Brass
9	Piezo propane burner Regulator hose set 0.5 – 1.5 bar with Hose rupture protection	9060010 9060015	with plug-in nipple Propane gas hose, 5 m with plug-coupling and LH ⅜" Pressure reducer, internal thread 21.7 x 1.814 G SW 30 mm, Stainless steel 1.4301
	Installation spanner for pressure reducer	9020070	
Z	Main valve unit		
10	Flame flashback/gas backflow arrester	1460045 1430015	ECO: Brass (2.0401) PREMIUM: Stainless steel (1.4301)
11	Main shut-off valve*	1360020	Nickel-plated brass
12	Test port for measuring the gas concentration with shut-off valve* and male coupler set	1360015 1460285 1460290 1460130 1450000	Ball valve, nickel-plated brass, G¼" IT Coupling socket G⅛" DN 2.7 Coupling socket G¼" DN 5 Screw-in connection with PU hose, 6 x 4 mm Blanking plug, PVC G¼" ET
13	Pressure gauge connection with quick coupler and shut-off valve*	7360824	Nickel-plated brass
14	Optional: Venturi nozzle with compressed-air connection (15) and shut-off valve*	1420025	PRO
16	Hook spanner 60–90 mm	7370114	Phosphated steel with joint
17	Single open-ended spanner, 36 mm	9070036	Phosphated steel
18	Pressure gauge -1–1.5 bar Pressure gauge -1–5 bar	1020000 1020005	63 mm diameter, Cl. 1.6, glycerin-filled 63 mm diameter, Cl. 1.6, glycerin-filled
19	Flat seal	8050050	NBR 70 Shore A, 44 x 33 x 2 mm diameter
20	Earthing cable	1450035	90 cm, connector on both ends, 25 mm²
21	Sound suppressor G 1" ET WAF 36	1420055	Stainless steel 1.4301
22	Assembly spanner	1420070	Stainless steel 1.4301

Table 2: Specification of system components

*All ball valves with a yellow handle, including the valve with the grey handle for the compressed-air feed at the Venturi nozzle, are DVGW-certified. A certificate is provided in Appendix 15.2.



Flaring device pressure-flow charts

The following chart describes the pressure-flow behaviour of the flaring device.

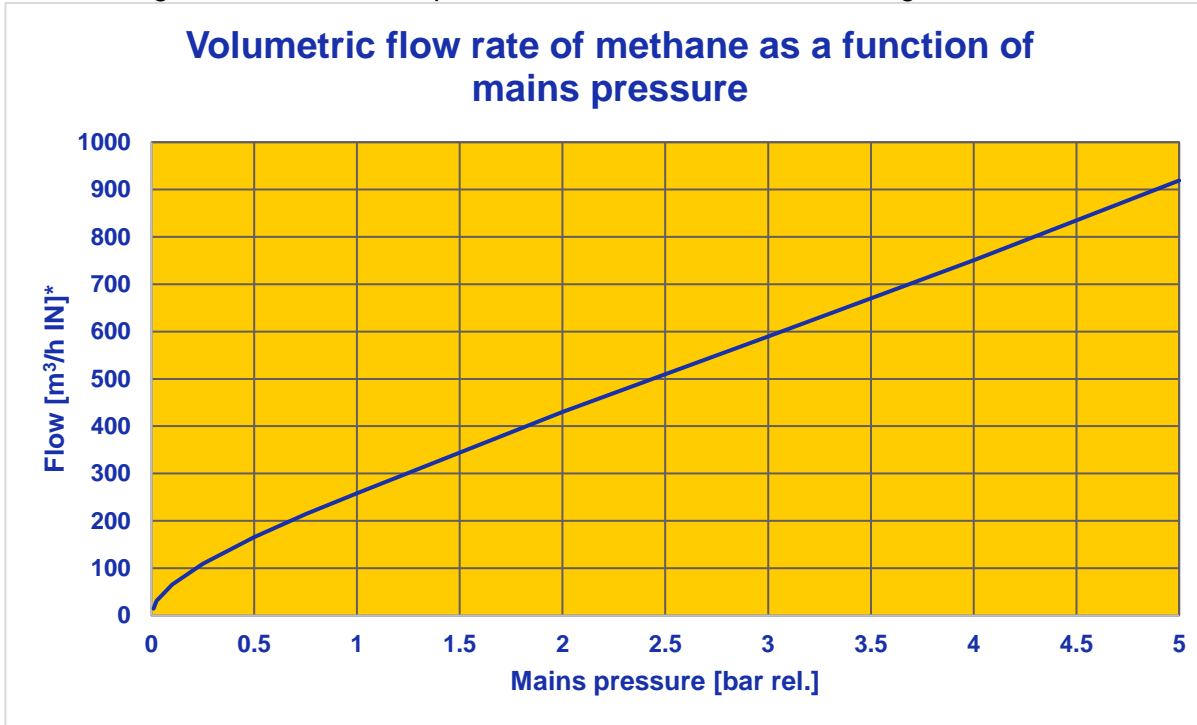

Figure 4: *Volumetric flow rate of methane as a function of mains pressure*

For Pro versions only: The chart below describes the relationship between the inducted volumetric flow rate and the outlet pressure at the compressor with a Venturi nozzle connected.

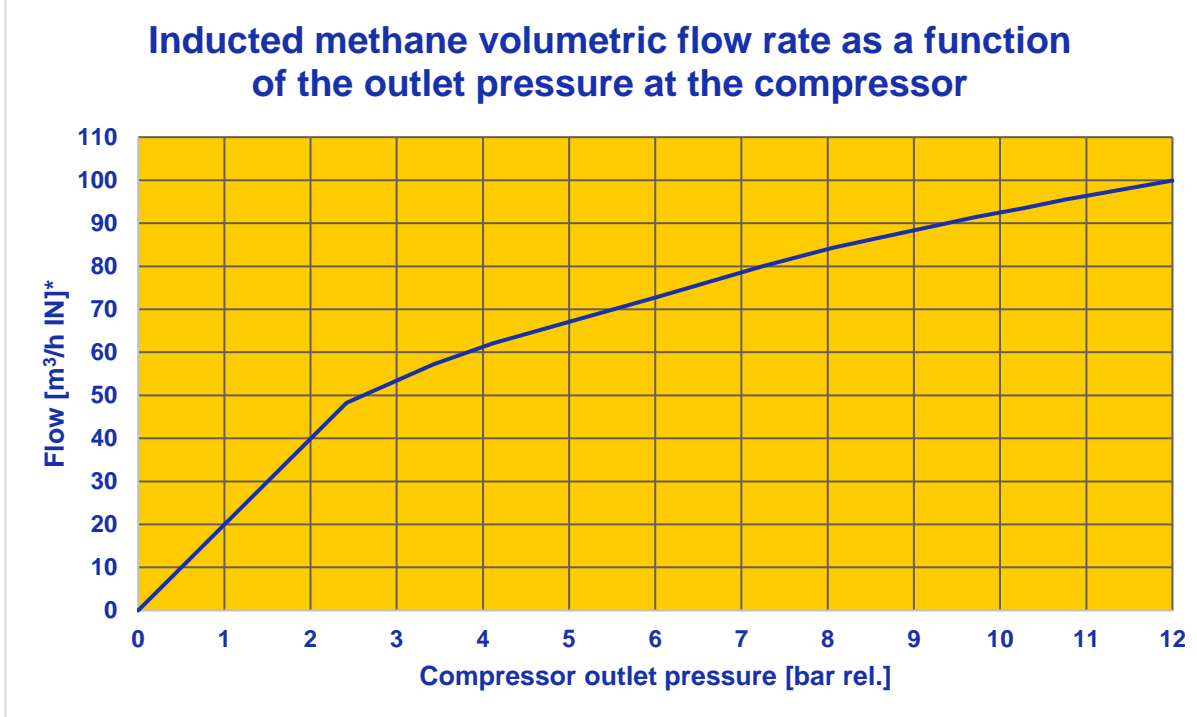

Figure 5: *Relationship between inducted methane volumetric flow rate and the compressor outlet pressure at the compressor*

* Explanation of Y axis in Figure 4: and Figure 5:

m³/h IN \triangleq standard cubic metres per hour at 0 °C & 1013.25 mbar.



4 Safety and responsibility



This section provides an overview of all relevant safety aspects for the optimum protection of persons as well as safe and trouble-free operation. Keep the operating instructions manual with the safety information for future reference.

4.1 Warning signs

For your own safety, it is important to read and fully understand the following table with the various warning signs and their definitions.







Symbol	Definition
 DANGER	Warns of an imminent hazard that, if not avoided, will result in death or serious injury. ▶ Measures to avoid the hazard.
 WARNING	Warns of an imminent hazard that, if not avoided, could result in serious injury. ▶ Measures to avoid the hazard.
 CAUTION	Warns of a hazardous situation that, if not avoided, could result in minor or moderate injury. ▶ Measures to avoid the hazard.
	Warns of flammable materials (ISO 7010 – W021).
	Warns of explosive substances (DIN 4844-2 – D-W021).
	Warns of the presence of gas cylinders (ISO 7010 – W029).
ATTENTION	Indicates a hazardous situation that, if not avoided, could result in physical damage. However, no actions in respect of personal injury are necessary. ▶ Measures to avoid the damage.

Table 3: Warning signs

4.2 Signs and symbols



Symbol	Definition
	This sign means that your device meets the safety requirements of all applicable harmonised EU directives.
	Notes: Contain particularly important information for understanding.

Table 4: Signs and symbols



4.3 Intended use

The flaring device is intended exclusively for burning off natural gas (methane), propane, biogas, city gas and long-distance gas quantities as well as hydrogen (separate degassing hose) in a controlled manner so that they do not enter the atmosphere and form ignitable mixtures or contribute to environmental pollution.

The device may be operated only by trained personnel. Intended use also includes observing this instruction manual. The maintenance intervals must be strictly observed.

Have your device repaired only by qualified professionals and only with original replacement parts. This ensures that the safety of the device is maintained.

Keep the device away from rain or moisture. The ingress of dust or water into the flaring device could impair the throughflow of the medium.

For cleaning, do not use any solvents. Otherwise, the surface of the device and its seals could be damaged. Use only a silicone spray, which should also be used for lubricating the locking pins.



4.4 Improper use

Any use not described above or any use that does not comply with the technical specifications is considered improper use. The user bears sole responsibility for any damage or loss arising from improper use.

The following types of use are prohibited:

- Use of the device in environments where corrosive liquids could enter the components.
- Introduction of any objects into the medium-conveying components of the flaring device.
- The attachment of non-system-compliant components or the swapping of components is not permitted. This would invalidate the warranty, and the manufacturer shall accept no liability.

The following safety information indicates hazards of a general nature that may arise when handling the flaring device. To minimise the severity of the hazard, the user must observe all the rules of conduct listed.

Symbol	Definition
 	 DANGER Risk of fire and explosion. <ul style="list-style-type: none"> ▶ Never use in enclosed spaces. ▶ Operation of the flaring device with natural gas flowing out is permitted only if full personal protective equipment is being worn (flame- and heat-resistant protective clothing including head protection, safety goggles and gloves). ▶ Never aim the flame at a person or flammable objects nearby.



Symbol	Definition
	<p>CAUTION</p> <p>Equipment damage caused by incorrect transport and storage.</p> <p>▶ For transport and storage, always use the intended carry case.</p>

Table 5: Warnings – improper use

In this manual, you will find additional warning notes for every action that involves a potential hazard.

4.5 Product safety with factory test report

The flaring device was designed and constructed based on state-of-the-art standards and practices. KROHSE GmbH takes its responsibility as the manufacturer of this safety-critical device seriously and carries out a two-step leak test on each device before it leaves the factory. The complete fitness for purpose is confirmed in a test report enclosed with the device.

The components of the flaring device and the supplied accessories are specifically designed to work together.



DANGER

If the device is used incorrectly or in a modified way, hazards could arise for the user, third parties and the environment, for which KROHSE GmbH shall bear no responsibility.



▶ Use only the original components and replacement parts from KROHSE GmbH



▶ Do not use any other complementary goods (hoses, adapters, fittings)

▶ Observe the instructions and requirements for pressure and use. Modifications are prohibited without the written consent of the manufacturer.

The natural gas flaring device must be operated only by persons who have received appropriate training in respect of the following:

- Working on gas-carrying lines,
- Knowledge of the danger posed by the natural gas flowing out,
- Proficiency with the function principle of the natural gas flaring device and
- Reading and understanding the operating instructions.

Standards:

- SVGW G2

Safety rules:

- SUVA “Erdgasleitungen: So arbeiten Sie sicher.” (Natural gas lines: Safe working practices)
- DGUV rules 100-500 Operating of working equipment Section 2.31 “Arbeiten an Gasleitungen” (Work on gas lines)



4.6 Manufacturer's declaration

Within the meaning of the Pressure Equipment Directive 2014/68/EU for an assembly

The manufacturer **KROHSE GmbH**
Gewerbestrasse 2
8212 Neuhausen am Rheinflall
Schweiz

Hereby declares that the pressure equipment (the assembly)

Description / Purpose of use Flaring device DN 25

Year of production: as of 2024

Serial number: 25-24-03/

	room 1	room 2
room designation:	Up to main shut-off valve:	Entire appliance incl. Venturi nozzle
max. permissible pressure PS (bar):	5	2
Volume V (litres):	0.309	0.506
Applied test pressure PT (bar):	8	3
Test date:		
Test medium	Nitrogen	Nitrogen
Fluid-Fluid group:	1 (during operation)	1 (during operation)

in accordance with the essential safety requirements (Annex 1) of the Pressure Equipment Directive 2014/68/EU. CE marking must not be applied, as all components are classified in accordance with Art. 4 Para. 3.

Lfd. no.	Designation of applicable documents	Revision / creation date
01	Assembly list Page 7 OM	03-2024
02	Operation manual D/E/FR/IT	03-2024

Applied standards and technical specifications:	AD 2000 regulations, good engineering practice according to Art. 4 Para. 3 DGRL 2014/68/EU
Other applied guidelines:	SVGW G2, SUVA "Natural gas pipelines: How to work safely.", DGUV Rule 100-500 Operation of work equipment, Chapter 2.31 "Working on gas pipes"
<i>Associated certificates</i>	(assembly)
Leak test certificate:	PS
Completeness check:	LS

Place, date:

Neuhausen am Rheinflall,

Thomas Krohse (Business owner)

 (Name, Function)

 (Signature)



4.7 Guarantee

The flaring device is covered by a guarantee of twelve (12) months. It begins from the delivery of the goods.

4.8 General terms and conditions of business

The currently valid general terms and conditions of business of KROHSE GmbH apply. These can be accessed at www.krohse.ch/download/



5 Scope of delivery



The flaring device is delivered with the following components in a robust carry case:

<p>A Riser unit with lower riser module 2, main valve unit Z, folding feet 3 and attached upper riser 5.</p> <p>4 Ground pegs (3 pcs)</p> <p>6 Degassing hose set (free choice of length)</p> <p>7 Coupler for degassing hose</p> <p>8 Connection adapter 2 ½" (1 pc), ¾" (2 pcs)</p> <p>9 Piezo burner set with propane gas hose, pressure reducer and installation spanner</p>	<p>12 Test port connector set: - Coupling socket DN 2.7 (1 pc), - Coupling socket DN 5 (1 pc), - Screw-in connection with PU hose 6 x 4 mm (1 pc) - PVC blanking plug, ¼" ET</p> <p>16 Hook spanner 60–90 mm (1 pc)</p> <p>17 Single open-ended spanner 36 mm (1 pc)</p> <p>18 Pressure gauge (1 pc -1–1.5 bar / 1 pc -1–5 bar)</p> <p>19 Flat seal (2 pcs)</p> <p>20 Earthing cable (1 pc)</p> <p>21 22 Sound suppressor including assembly spanner (1 pc each)</p>
--	---

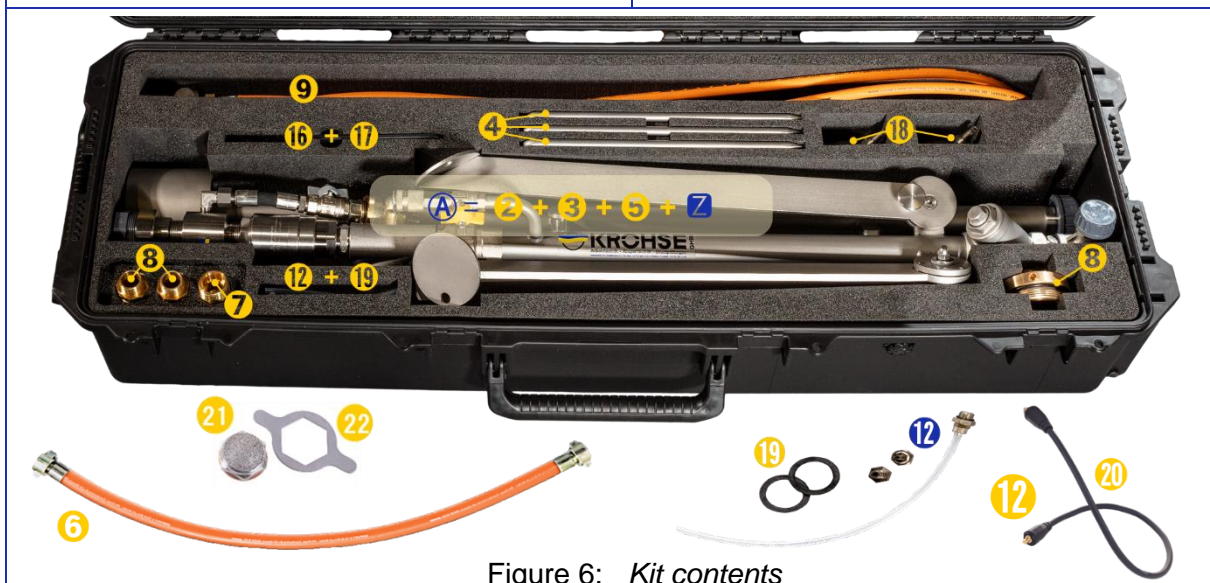

Figure 6: *Kit contents*

Necessary supplementary products (not included)

- Personal protective equipment (PPE) for working on gas lines
- Warning signs
- Gas detector
- Propane gas cylinder (preferably transparent for fill level checks)
- Plastic mallet or non-sparking tool for ground pegs
- Information about the affected line section (operating pressure, volume, surrounding shut-off valves, medium)

Only when using a Venturi nozzle

- Construction site compressor for oil-free compressed air with pneumatic dog clutch (min. 8 bar to max. 17 bar)



6 Assembling the flaring device

6.1 Tools for assembly/disassembly



All connections required for assembling/disassembling the flaring device can be tightened or untightened either by hand or with the supplied assembly spanners.

To secure the feet safely in the ground, you require a **plastic mallet** or a metal hammer made of a **non-sparking material** to drive in the ground pegs.

6.2 Prerequisites for setting up the flaring device

Ensure that the flaring device is set up on a **flat and stable surface**. Choose a safe and hazard-free location that

- is completely clear above the open flame.
- is free of vegetation, electrical devices or other sources of ignition in the high-risk work area.
- poses the lowest possible hazard potential for your own personnel and third parties.
- can be quickly and safely evacuated and has at least two escape routes in different directions.
- as far as possible minimises noise emissions for the surrounding population.
- For securing on asphalt-surfaced ground, the feet must be secured to ground plates or similar.



6.3 Assembly and set-up

6.3.1 Opening the transport trolley

Place the transport trolley ① on a flat and stable surface. Open the six (6) trolley tabs. To do this, first press the tab catch inwards (step ①) and, with the catch pressed in, fold the trolley tabs upwards (step ②).

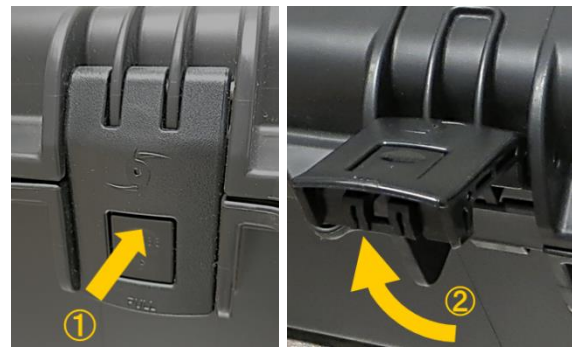

6.3.2 Erecting the lower riser module

Remove the riser unit A (comprising lower riser module ② with main valve unit Z and folding feet, and the attached upper riser) from transport trolley ①.



Make sure that the upper riser is securely attached in the bracket and locked in place by the two locking pins.

Now, at the chosen work position, carefully stand the riser unit A vertically on the grey PVC protective cap that seals the upper riser (step ①). Loosen the locking pins (step ②) and fold all three feet down (step ③) until you hear the sprung locking pins engage and the feet are locked in position.

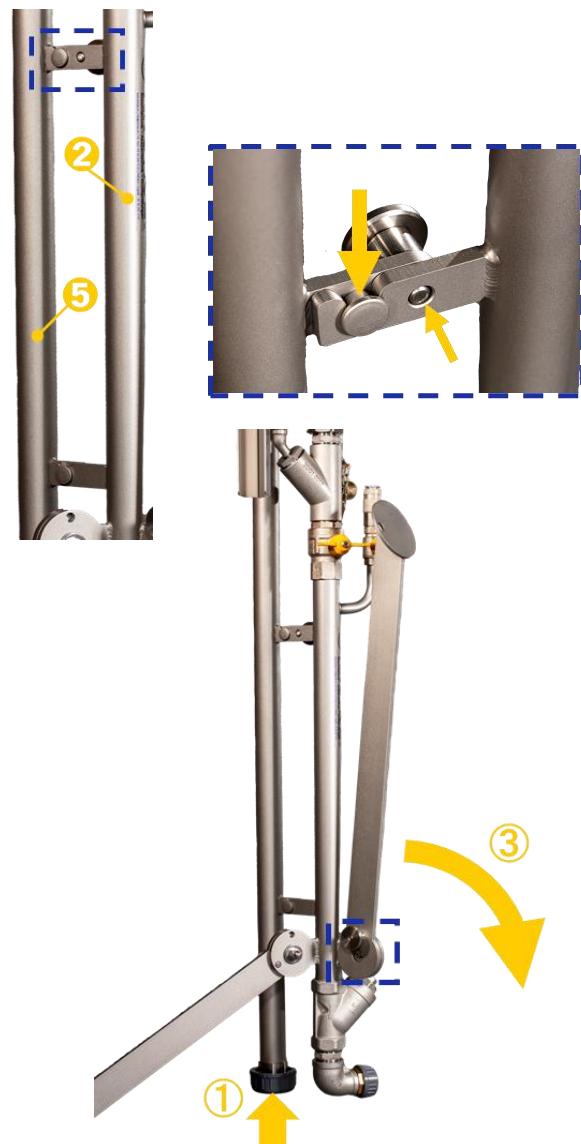



Now ensure safe footing by driving in the ground pegs **4** using a plastic mallet or a metal hammer made of a **non-sparking material** until they are flush with the ground. Make sure that the ground peg with the earth connection is pointing towards the riser and do not connect the cable until after the peg has been driven in.

For protection against unwanted sparking, connect the black earthing cable **20** to the socket provided on the lower riser **2**, and now connect the earthing cable to the earthing socket on ground peg **4**. Be sure to plug the connectors into the sockets fully and turn them clockwise to secure.

Check that all valves of the main valve unit **Z** are easy to operate. Now close all of the valves to prevent the inadvertent escape of gas during assembly.

 **All yellow valve levers must be in a horizontal position.**

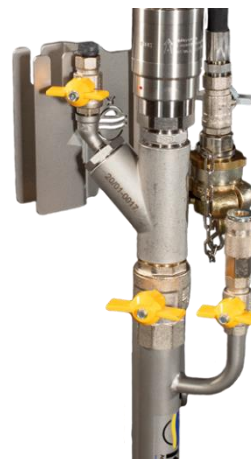
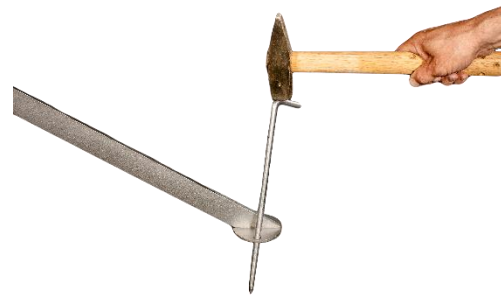



6.3.3 Assembling the upper riser

To avoid extreme noise emissions during flaring from medium-/high-pressure lines or during the evacuation of residual gas through the Venturi nozzle, you have the option to fit a sound suppressor **21** or to the designated 1" internal thread of the diffuser on the upper riser. This achieves a noise reduction of approximately 50%. Screw the sound suppressor in hand-tight using the assembly spanner **22**.

Loosen all three grey PVC protective caps/plugs (**J**), (**K**) and (**L**) and return them to the transport trolley for safekeeping.

i As you loosen the protective plug **J**, take care not to lose, damage or contaminate the flat seal **19** on the connection point.

Release the upper locking pin and remove the upper riser **5** from the brackets on the riser unit **2**.



Now fasten the upper riser to the lower riser at the connection point **V**. Ensure that

- The upper riser is aligned with the lower riser,
- The flat seal **19** is positioned centrally,
- The threaded connection can be screwed together easily.

Fasten the connection hand-tight first. Then further tighten the connection through 30–45° using the two assembly spanners **16** and **17**.

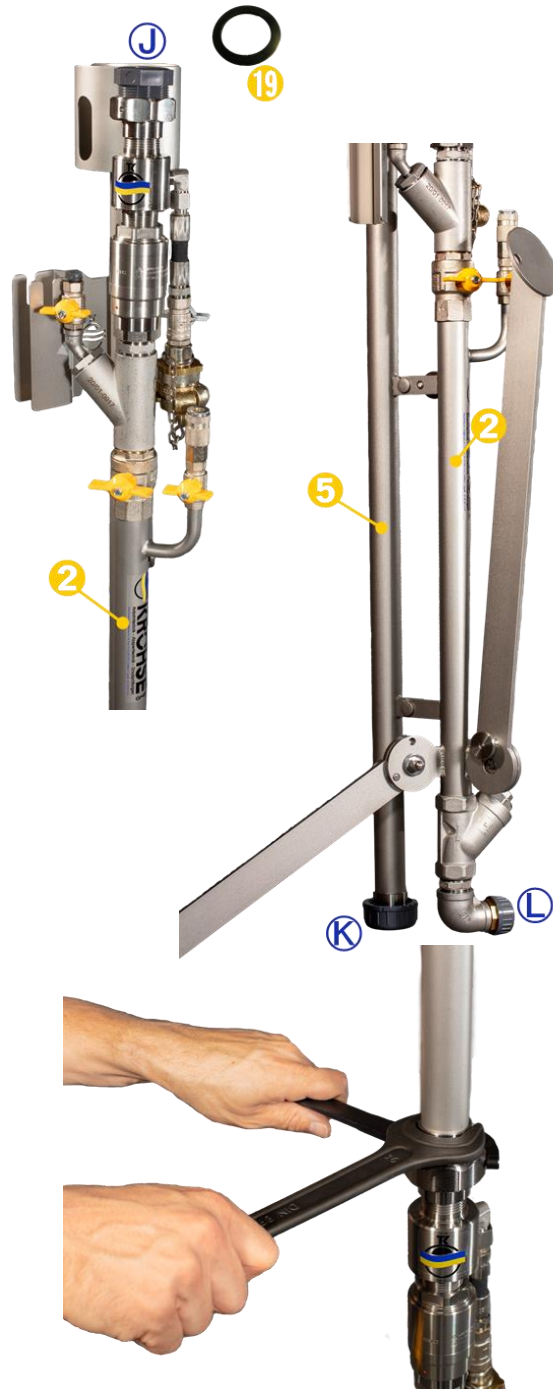



6.3.4 Fitting the degassing hose

Now fasten one end of the degassing hose **6** to the elbow of the lower riser hand-tight using the threaded coupler (O-ring – taper).

Fasten the other end of the degassing hose to the natural gas line or the inflatable stopper installer hand-tight.

i If required, use the supplied connection adapter **8** ¾" or 2 ½" (for connection to a ball valve).

6.3.5 Fitting the piezo burner

Take the piezo burner set **9** from the transport trolley and attach the piezo burner to the designated bracket on the upper riser.

Swivel the burner nozzle into the designated opening in the diffuser (step **1**). Now slide the burner downwards until it fully engages in the bracket (step **2**). Now connect the hose coupling from the propane hose to the plug nipple on the secondary burner

Then screw the connection on the pressure reducer (at the opposite end of the orange propane gas hose) onto the **left-hand** thread on the propane gas cylinder and fasten gas-tight.

6.3.6 Pressure gauge connection

Select the appropriate pressure gauge **18** for your intended working pressure range:

- -1–1,5 bar
- -1–5 bar

Insert the pressure gauge **18** at the pressure gauge connection **13** into the opening provided until you hear it click into place.

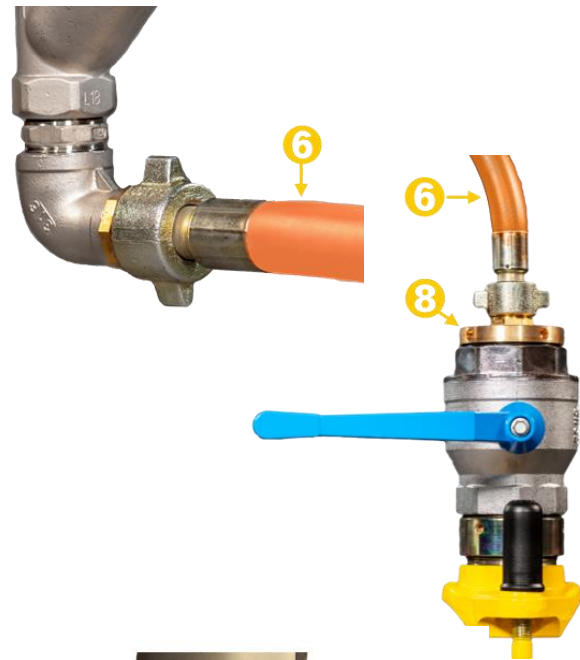



7 Preparations for safe operation



DANGER

During work on live natural gas lines, there is a risk of fire and explosion.



► For this reason, the applicable national safety rules and regulations must be strictly observed.

For example:

- Swiss National Accident Insurance Fund SUVA “Erdgasleitungen: So arbeiten Sie sicher.” (Natural gas lines: Safe working practices) Or
- Occupational health and safety rules BGR 500 Section 2.31 “Arbeiten an Gasleitungen” (Work on gas lines)

In particular, note that:

- Work on gas lines must be carried out only by suitable, reliable and trained personnel.
- Only those persons are permitted in the hazard zone who are directly involved in the work.
- Personnel must wear the prescribed personal protective equipment (with flame- and heat-resistant protective clothing including head protection, safety goggles and gloves) during operation of the flaring device.
- There must be no sources of ignition, electrical devices or vegetation present in the work area.
- There must be no possibility of sparking, e.g. caused by passing road vehicles, railway vehicles and non-explosion-proof construction machinery or by electrical (battery change) or electrostatic discharge events.
- The hazard zone must have been clearly demarcated using appropriate warning signs.





8 Commissioning



Before your flaring device undergoes commissioning, make sure that

- The propane gas cylinder is large enough and sufficiently filled for the entire duration of the work.
- The secondary flame does not go out at any time during operation.
- The work remains possible even if there is a sudden gust of wind.

8.1 Function and leak testing before commissioning

As preventive safety measures, the following tests and function checks must be carried out before the start of the flaring process.

Test	Remedial measure
<p>8.1.1 Propane gas line leak</p> <p>Open the propane gas cylinder but leave the controller on the burner closed for the time being. Now inspect the connection points.</p>	<p>► If leaks are found, the propane gas supply must be interrupted, the line must be vented and the connections retightened or components (seals/hoses) replaced.</p>
<p>8.1.2 Leak test</p> <p>Make sure that all valves on the flaring device are closed. Open the shut-off valve on the gas line. Now check the leak-tightness of the connection points of the degassing hose all the way to the flaring device using a gas detector or by using soapy water.</p>	<p>► If leaks are found, the gas supply at the shut-off valve of the natural gas line must be closed, the line must be vented and the connections retightened or components (seals/hoses) replaced. In cases of doubt, contact KROHSE GmbH.</p>

Table 6: Function tests before commissioning

For safety reasons, you must follow the procedure below precisely when commissioning your flaring device:



During work on live gas lines, there is a risk of fire and explosion.

- Operation of the flaring device with natural gas flowing out is permitted only if full personal protective equipment is being worn (flame- and heat-resistant protective clothing including head protection, safety goggles and gloves).



8.2 Without Venturi nozzle (STANDARD)

The procedure below describes the commissioning process for the two flaring device variants ECO-STANDARD and PREMIUM-STANDARD.

8.2.1 Igniting the secondary flame

Open the valve on the propane gas cylinder. Set the pressure reducer to the minimum working pressure.



Fully anti-clockwise!

Then fully open the valve ① on the piezo burner and immediately press the igniter ② – repeatedly if necessary – until the flame on the burner is lit.

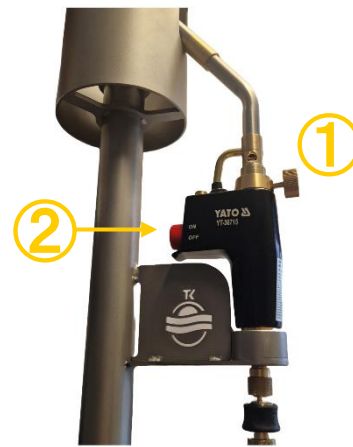

8.2.2 Opening the gas supply

Open the shut-off valve on the natural gas line and then the main shut-off valve on the flaring device.



WARNING

Make sure that the flame on the diffuser does increase in size but propagates as vertically as possible so as not to pose a hazard.



The secondary flame must be ignited before the main shut-off valve is opened!



8.2.3 End of the flaring process

Towards the end of the flaring process, there is a clear decline in gas pressure at the pressure gauge and the flame diminishes (image ②).

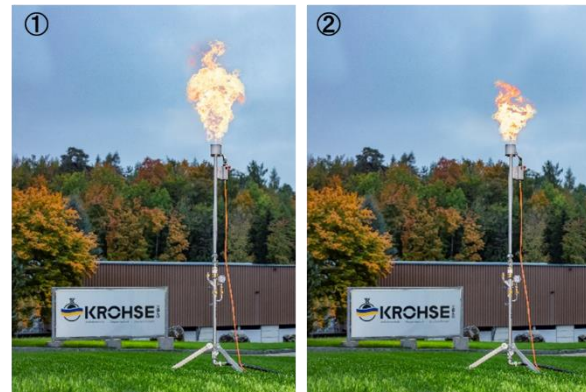

It is advisable to carry out a gas concentration measurement using the connected gas detector. To do this, connect the gas detector to the test port ⑫ using the supplied adapters and open the valve on the test port to carry out the concentration measurement.

ATTENTION: The gas concentration measurement must be carried out only when the gauge pressure in the gas line is near zero. The main shut-off valve must therefore be closed ⑪ during the measurement. In addition, the gas concentration measurement must not be carried out when the Venturi nozzle is active (valve on the compressed-air connection closed).



An overview of the volumetric gas flow rate [m³/h] at different gas pressures can be found in Figure 4: on page 8.

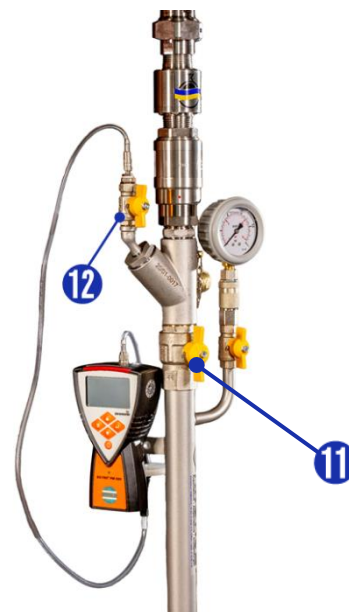

8.2.4 Shutting down the flaring device

Close the shut-off valve on the propane gas cylinder. This allows the residual propane gas to dissipate towards the burner. Now fully close the valve ① on the piezo burner.

Remove the gas detector from the test port.

Open all valves on the main valve unit to release the trace amounts of residual gas.





8.3 With Venturi nozzle (PRO)

The procedure below describes the commissioning process for the two flaring device variants ECO-**STANDARD** and PREMIUM-**PRO**. Thanks to the integrated Venturi nozzle, these variants are suitable for the complete “evacuation” of a line, e.g. for complete **degassing** in the event of line decommissioning or to remove all gas from an isolated line section before separation takes place.

8.3.1 Igniting the secondary flame

Open the valve on the propane gas cylinder.
Set the pressure reducer to the minimum working pressure.



Fully anti-clockwise!

Then fully open valve ① on the piezo burner and immediately press the igniter ② – repeatedly if necessary – until the flame on the burner is lit.



8.3.2 Opening the natural gas supply

Open the shut-off valve on the natural gas line and then the main shut-off valve on the flaring device.



WARNING

Make sure that the flame on the diffuser does increase in size but propagates as vertically as possible so as not to pose a hazard.



The secondary flame must be ignited before the main shut-off valve is opened!



8.3.3 End of the flaring process

Towards the end of the flaring process, there is a clear decline in gas pressure at the pressure gauge and the flame diminishes (image ②).

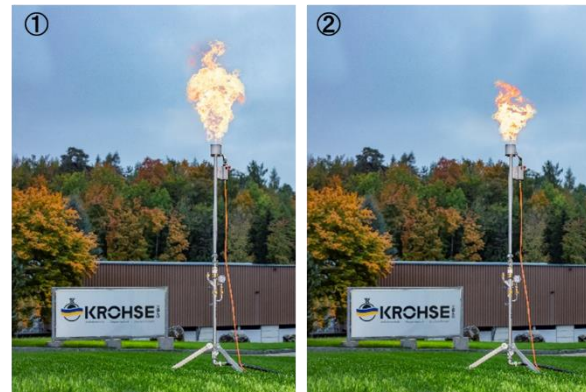

It is advisable to carry out a gas concentration measurement using the connected gas detector. To do this, connect the gas detector to the test port ⑫ using the supplied adapters and open the valve on the test port to carry out the concentration measurement.

ATTENTION: The gas concentration measurement must be carried out only when the gauge pressure in the gas line is near zero. The main shut-off valve must therefore be closed ⑪ during the measurement. In addition, the gas concentration measurement must not be carried out when the Venturi nozzle is active (valve on the compressed-air connection closed).

An overview of the volumetric gas flow rate [m³/h] at different gas pressures can be found in Figure 4: on page 8.

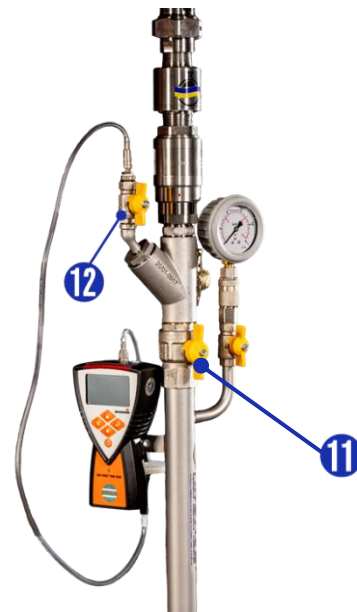



8.3.4 Evacuating the line

To extract the residual volume of gas in the line, the Venturi effect is used: Compressed air flowing out generates a negative pressure in the line.

At the Venturi nozzle **14**, oil-free compressed air is inducted by the compressed-air connection **15**.



Use only construction air compressors that allow oil-free preparation of compressed air and can limit the outlet pressure to min. 8 bar and max. 17 bar.

Make sure that the natural gas line can vent itself during the evacuation process. To do this, when you switch on the compressed air, simultaneously open a vent valve located on the other end of the gas line facing away from the flaring device.

When the primary flame goes out, stop the supply of compressed air by closing the valve on the compressed-air connection.

Now measure the gas concentration. If the measured value is 50% below the explosive limit concentration, you can proceed with shutting down the flaring device (8.3.5). If this concentration has not yet been reached, continue to evacuate the line (in accordance with 8.3.4)



8.3.5 Shutting down the flaring device

Close the shut-off valve on the propane gas cylinder. This allows the residual propane gas to dissipate towards the burner. Now fully close the valve **1** on the piezo burner.

Remove the gas detector from the test port.

Open all valves on the main valve unit to release the trace amounts of residual gas.





8.4 Explosive concentrations

During work with flammable gases, knowledge of the explosive concentration limits is vital:

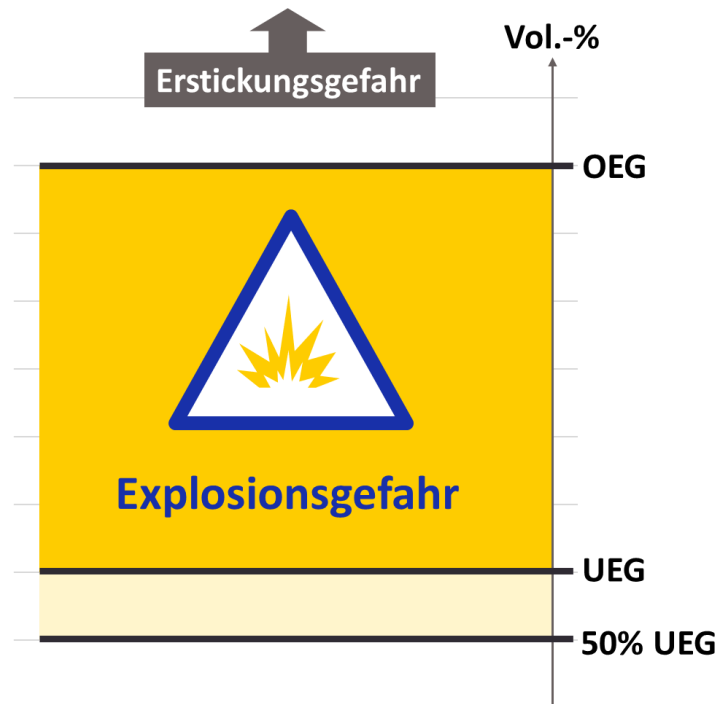

Gas concentrations as volume percentage [vol. %]

Gas	Danger limit > 50% of the LEL	LEL Lower explosion limit	UEL Upper explosion limit
Natural gas	2%	4%	17%
Propane	0.8%	1.7%	12%
Butane	0.7%	1.5%	9%
Acetylene	0.7%	1.5%	82%
Hydrogen	2%	4%	76%
Petrol	0.3%	0.6%	8%

Table 7: Gas concentrations



9 Disassembling the flaring device

9.1 Tools for disassembly



All connections required for disassembling the flaring device can be loosened either by hand or with the supplied assembly spanners.

9.2 Disassembly and removal

9.2.1 Disconnecting the pressure gauge

Pull the locking sleeve on the pressure gauge connection **13** down slightly to make it possible to remove the pressure gauge **18**.

With the connection facing upwards, return the pressure gauge **18** to the designated storage compartment in the transport trolley.



9.2.2 Removing the piezo burner

Check that the shut-off valve on the gas cylinder is fully closed. Loosen the **left-hand** thread of the pressure reducer connection (at the opposite end of the orange propane gas hose) from the propane gas cylinder.

Disconnect the plug-in coupling on the propane hose from the secondary burner and push it upwards until it comes free from the bracket (step **1**). Then swivel the burner nozzle out of the opening in the diffuser (step **2**).

Return the cooled piezo burner set **9** to the designated compartment in the transport trolley.

ATTENTION: The piezo burner set must not be stowed in the transport trolley until it has fully cooled. → Fire hazard!





9.2.3 Removing the degassing hose

Make sure that the shut-off valve on the natural gas line is closed. Remove both ends of the degassing hose **6** (from the elbow of the lower riser on the flaring device) and from the other end together with the connection adapter **8** (on the natural gas line/inflatable stopper installer).

Roll up the degassing hose and bind it using the strap supplied.

9.2.4 Removing the upper riser

Now loosen the union nut at the connection point **V** using the two assembly spanners **16** and **17**, and remove the upper riser **5**.



Take care not to lose, damage or contaminate flat seal **19** on the lower connection point.

Remove the sound suppressor **21** from the upper riser in the diffuser using the assembly spanner **22**. If required, clean the sound suppressor.

Attach the upper riser **5** to the brackets of the lower riser unit **A**. To do this, pull the upper locking pin back and then re-engage it to ensure that the upper riser is securely locked in place.

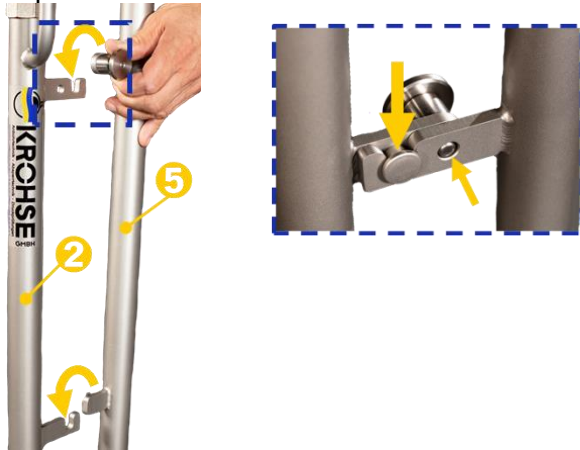

Now take all three grey PVC protective caps/plugs (**J**, **K** and **L**) from the transport trolley and screw them into place.





9.2.5 Pulling the ground pegs

Remove the earthing cable (20) and pull the ground pegs (4) out of the ground. Clean the ground pegs using a damp cloth and return them to the designated compartment in the transport trolley.

9.2.6 Dismantling the lower riser module

Loosen the locking pins (step 1) and fold all three feet upwards (step 2) until you hear the sprung locking pins and the feet are locked in the uppermost position.



In the process, stand the riser unit (A) = (2) + (5) carefully on the grey PVC protective cap (K) that seals the upper riser (step 3).

i Make sure that the upper riser is securely attached in the bracket and locked in place by the locking pins.

Finally, place the riser unit (A) (with upper riser attached) in the transport trolley (1) with the upper riser facing downwards and the two feet facing upwards.

i Note: The "KROHSE label" faces upwards.

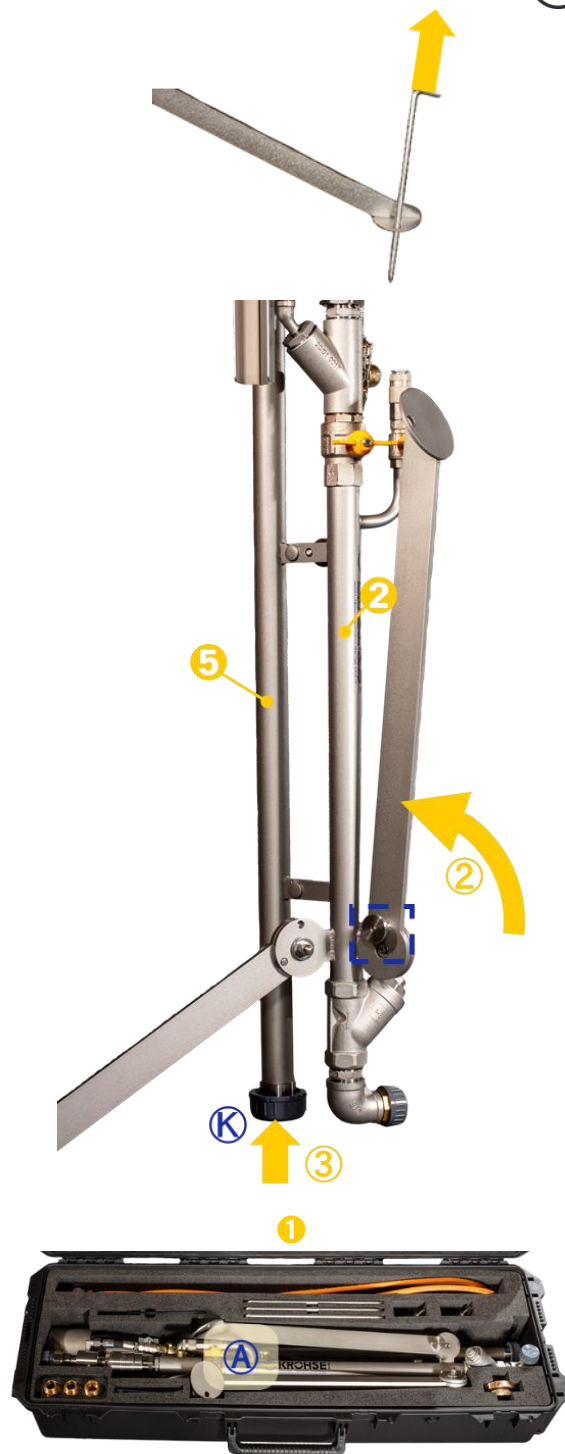



10 Troubleshooting



A fault or malfunction can often be easily rectified by some simple remedial measures.

10.1 Fault causes and remedial measures

Fault cause	Description ▶ Remedial measure
Flame flickers significantly	Strong wind ▶ Find shelter from the wind or carry out the work in better weather conditions Not enough propane gas in the cylinder ▶ Replace the propane gas cylinder
Pressure does not drop to zero towards the end	Gas line shut-off not 100% leak-tight ▶ Make sure that the shut-off valve is fully closed or improve the effectiveness of the inflatable stoppers (use stoppers for higher pressures or double stoppers).
Valves leaking or stiff to move	Shut-off valve no longer functioning ▶ If the shut-off valves cannot be fully opened or closed correctly, the affected components on the flaring device must be replaced after consultation with KROHSE GmbH.
Connection point stiff to move or leaking	External thread damaged (impact damage) ▶ Rework the thread after consultation with KROHSE GmbH External thread fouled ▶ Clean the thread and then lubricate with silicone spray Seal damaged/no seal fitted ▶ Check and fit a new flat seal
Foot does not engage	Locking pin not engaging (deformation of the foot) ▶ Rework the bore hole slightly using a file ▶ Replace the foot
Sliding sleeve on the pressure gauge connection does not move	Coupler operated without pressure gauge ▶ Pull the locking sleeve back and refit the pressure gauge ▶ Lubricate the locking sleeve with silicone spray
Piezo burner not igniting	Not enough propane gas in the cylinder ▶ Replace the propane gas cylinder Ignition mechanism defective ▶ Replace the piezo burner Pressure reducer defective ▶ Replace the pressure reducer

Table 8: Fault causes and remedial measures



10.2 Technical support

Technical support for the flaring device



Watch our detailed video guide at
www.YouTube.com Search term: “**Abfackelgerät KROHSE**”



+41 (0) 52 202 10 51



info@krohse.ch

11 Storage and transport



To ensure that your flaring device is always protected from dust, dirt, moisture and damage, always keep the device safely stored in the carry case when out of use.

If it is necessary to carry the flaring device inside the transport trolley (30 kg), this should be done by two persons holding the side carry handles to avoid overexertion. If only one person is available, the transport trolley and riser unit can be carried separately.



12 Maintenance and repair

12.1 Cleaning and care



Clean your flaring device with silicone spray after it has cooled. Never use corrosive or abrasive products as this could damage the anti-corrosion protection and seals.

12.2 Maintenance

Check after use: After each use, it is necessary to inspect the KROHSE flaring device for sound condition and cleanliness of components.

Table 9 below provides an overview of the components on your flaring device that require regular maintenance:

Component	Maintenance and frequency	Maintenance level	Carried out by
Compressed-air connection on the Venturi nozzle	Regular maintenance after each use <ul style="list-style-type: none"> • Check the seal, shut-off valves and hose • Lubricate the safety clutch with silicone spray for good ease of movement 	L1	User
Degassing hose set	Regular maintenance after each use <ul style="list-style-type: none"> • Check the O-rings 	L1	User
Piezo burner set	Regular maintenance after each use <ul style="list-style-type: none"> • Check that the components are in a sound condition (cracks in the hose, impact damage to the burner and pressure reducer, etc.) 	L1	User
Pressure gauge, pressure gauge coupler	Regular maintenance after every 3rd use <ul style="list-style-type: none"> • Check that the connections are clean and undamaged • Lubricate with silicone spray 	L1	User
Prefilter	Regular maintenance after every 3rd use <ul style="list-style-type: none"> • Filter cap removal • Remove the screen and blow out with compressed air • Fit the screen and fasten the filter cap firmly (PTFE seal must be present on the cap) 	L1	User
Sound suppressor	Check regularly and, if necessary, clean with compressed air	L1	User

Table 9: Maintenance level 1



Component	Maintenance and frequency	Maintenance level	Carried out by
Complete flaring device	Annual maintenance <ul style="list-style-type: none"> • Leak test of the entire unit including pressure gauges and degassing hoses • Accuracy test of the pressure gauges • Clean all fitted filters (prefilter, main filter in the flame flashback/gas backflow arrester) • Function test of the piezo burner set 	L2	KROHSE GmbH or service partner

Table 10: Maintenance level 2

Maintenance level

L1: Carried out by the user of the flaring device.

L2: Must be carried out by a technician at KROHSE GmbH or one of its service partners.

It is prohibited for a level 2 maintenance service to be carried out by the user or by another technician not appointed by KROHSE GmbH or its service partners. This would result in instant invalidation of the guarantee and a release of liability.

Tampering with or modification to components of the device result in instant invalidation of the guarantee and a release of liability.

For the annual maintenance (L2) or repair of your KROHSE flaring device, please send the complete device including all components and accessories inside the transport trolley to the manufacturer KROHSE GmbH or one of its service partners.

12.3 Wear of components

The wear life of the degassing hose and propane gas hose is 8 (eight) years.

External factors (temperature, UV light, media contact, heavy mechanical loading, etc.) could lead to premature embrittlement of the hoses. For this reason, check these components regularly.



12.4 Cleaning/replacing the prefilter

Clean the prefilter after every 3rd use of your flaring device.

To do this, loosen the screws on the filter housing **31** on the lower riser module **2** using a 4 mm Allen key.



i When removing and installing the filter housing, ensure that the O-ring seal is intact. **32** If this is damaged, the O-ring must be replaced. In addition, the notch on the filter housing must be aligned with the upper- and lower-parts during assembly.

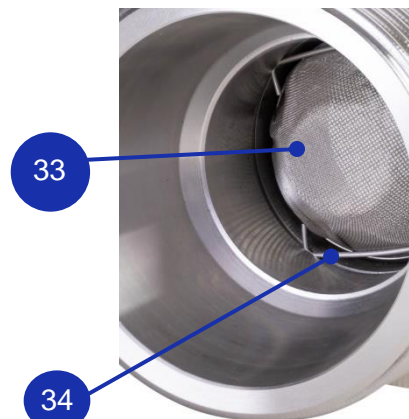

Dismantle the clamping spring **34** and remove the pre-filter **33**, check it for damage and clean it with compressed air.

When inserting the prefilter screen **33** and the clamping spring **34** make sure they are in the correct position. Now place the filter housing **31** on the lower riser module **2** on the flange and tighten the Allen screws evenly crosswise to make it gastight.

Check the condition of the sound suppressor **21** regularly and clean it with compressed air.





13 Accessories



The following replacement parts and accessories are available.

	Component	Item no.	Specification
1	Transport trolley	9050000	HPX
3	Foot	1420010	Stainless steel 1.4301
4	Ground peg	1420005	Stainless steel 1.4301
	Ground peg with cable socket	1420045	Stainless steel 1.4301
6	Degassing hose set	8050090	GWPB DN 19 x 4.5 mm for propane/natural gas, PN 20, ISO 3821 (free choice of length) with brass coupler at both ends (female taper G1" ET)
7	Coupler for degassing hose 1" ET x 1" ET	1460085	Brass, both ends Female taper with G1" ET
8	Connection adapter	1460040	Brass
	• 2 1/2" ET	7370232	
	• 3/4" ET		
9	Piezo propane burner Regulator hose set 0.5 – 1.5 bar with Hose rupture protection	9060010	with plug-in nipple
		9060015	Propane gas hose, 5 m with plug-coupling and LH 3/8"
			Pressure reducer, internal thread 21.7 x 1.814 G
	Installation spanner for pressure reducer	9020070	SW 30 mm, Stainless steel 1.4301
12	Blanking plug on the test port	1450000	PVC, 1/4" ET
16	Hook spanner, 60–90	7370114	Phosphated steel with joint
17	Single open-ended spanner, 36 mm	9070036	Phosphated steel
18	Pressure gauge -1–1.5 bar	1020000	63 mm diameter, Cl. 1.6, glycerin-filled
	Pressure gauge -1–5 bar	1020005	63 mm diameter, Cl. 1.6, glycerin-filled
	Pressure gauge protective cap	8050040	Rubber, grey
19	Flat seal 44 x 33 x 2 mm	8050050	NBR 70 Shore A
20	Earthing cable	1450035	90 cm, connector on both ends, 25 mm ²
21	Sound suppressor G 1" ET WAF 36	1420055	Stainless steel 1.4301
22	Assembly spanner (sound suppressor)	1420070	Stainless steel 1.4301
J	PVC plug at top of lower riser module	1450010	PVC, 1 1/2" ET
K	PVC cap at the bottom of the upper riser	1450015	PVC, 1 1/2" IT
L	PVC cap at the bottom of the elbow on the lower riser module	1450005	PVC, 1" IT
	Strap for the degassing hose set	80500XX	depending on the hose length



31	Filter housing Filter housing from year of manufacture 2024		Stainless steel 1.4301 Stainless steel 1.4301
32	PTFE seal O-Ring Ø 37x2 mm from year of manufacture 2024	1450020 8050375	PTFE 42.8 x 40.3 diameter x 1.4 mm NBR 70 Shore A
33	Prefilter screen Prefilter screen from year of manufacture 2024	1430025 1430090	Stainless steel 1.4301 Stainless steel 1.4305
34	Clamping spring	1430250	Stainless steel 1.4305
35	Screw Spring ring	1430285 1420215	M5 x 16 mm, Edelstahl 1.4305 Ø 5 x 8.8 mm, Edelstahl 1.4301

Table 11: Replacement parts and accessories

14 Disposal

The flaring device can be taken to a conventional disposal point offering environmentally responsible recycling of metals, plastics and special waste.



15 Appendix

15.1 Data sheet: Flame flashback/gas backflow arrester

Safety Device



The safety device (non-return valve / flashback resistant) **GRS25-VA:**

Type GRS25-VA for protection of pipelines, tapping points and equipment

The safety device GRS25-VA:

- avoids dangerous gas mixtures by a gas non-return valve (NV)
- flashback-resistant if compressed air is used as oxidant
- a dust filter protects the gas non-return valve against contamination
- every safety device is 100% tested
- all metal components in stainless steel 1.4305 / spring 1.4310

Safety elements of the IBEDA non-return valve GRS25-VA:

- NV Gas non-return valve

Additional features:

- DF Dust filter



For further information: <http://www.ibeda.com/en/gas-non-return-valves>

Maintenance:

The safety devices are to be tested by a qualified and authorised person at regular intervals according to country specific regulations. The safety device is to be tested for gas tightness and gas return at least once a year.

It is not allowed to open the safety devices.

For the female connection sizes G1RH F/F and 1NPT F/F the dust filter may be replaced by a qualified person.

Technical Data:				
Safety device GRS according to DIN EN ISO 5175-2: Flashback resistant if compressed air is used as oxidant.				
Gas types :	Industrial gas C	Hydrogen (H)	Natural Gas (Methane) (M)	Propane (P) cleaned Bio gas (M)
Working pressure:	0,15 MPa 1,5 bar		0,5 MPa 5 bar	0,5 MPa 5 bar
Cracking pressure:	4 to 6 mbar position-independent			
Gas temperature:	-20°C up to +70°C (Oxygen -20°C up to +50°C)			
Ambient temperature:	-20°C up to +70°C			
Threads: DIN ISO 228 ANSI/ASME B1.20.1	G1RH F/F ³⁾ G3/4RH F/F ³⁾ G1/2RH F/F ³⁾ 1NPT F/F ³⁾ 3/4NPT F/F ³⁾ 1/2NPT F/F ³⁾			
Measure and weight:	diameter:	length:	weight:	
G1 - 1NPT:	55 mm	108 mm	1,1 kg	
G3/4 - 3/4NPT:	55 mm	121 mm	1,2 kg	
G1/2 - 1/2NPT:	55 mm	103 mm	1,1 kg	
Application:	Heating burner, gas mixing- and control systems, applications according to EN 746-2			

Other materials, surface finishing, gas types and additional connections available on request.

³⁾ F = Female, M = Male



Safety Device

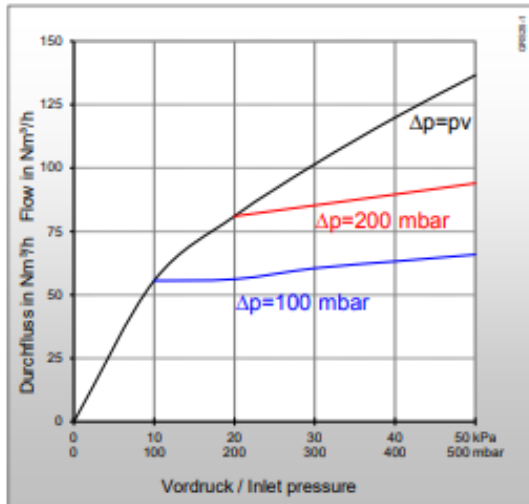
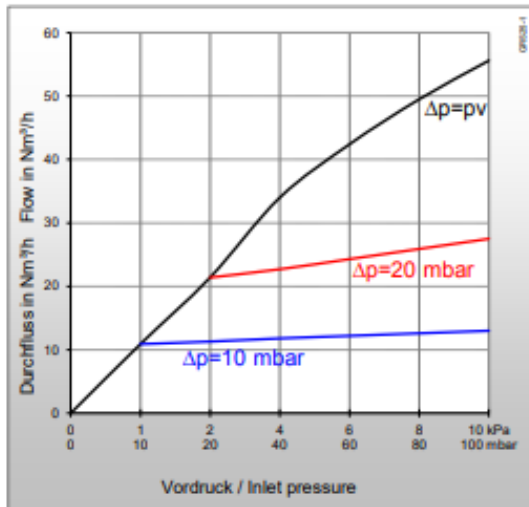

Example flow rate type: GRS25-VA G1 F/F.
Values for other connections on request.

Declaration of conformity

We, the manufacturer, hereby declare that the safety devices in accordance with the requirement of the following directives and standards

Directive: 2014/68/EU Pressure Equipment Directive

Standard: DIN EN ISO 5175 Part 2

As per the Pressure Equipment Directive 2014/68/EU for pressure keeping equipment with DN ≤ 25 mm for gases of group 1 and gases of group 2 Model GRV, Article 4 Para. 3, Article 5 Para. 1 (Good engineer practice and knowledge).

The manufacturer of these products is neither allowed to issue an EU-conformity declaration nor to provide CE-marking on the product.

Type: GRS25-VA

Flow rates [air]:

pv = Primary pressure

ph = Secondary pressure

Δp = Primary pressure minus Secondary pressure

Conversion Factors:

10 kPa = 100 mbar = 0,01 MPa = 0,1 bar = 1,45 psi

1 m³/h = 35,31 cu ft/h

	H	P	L	M	M	O
QG ▶	H ₂	C ₃ H ₈	C ₃ H ₆	CH ₄ +C	CH ₄	O ₂
F	3,8*	0,90	0,92	1,25	1,4	0,95

* Conversion factor 2.5 for devices comprising a flame arrester
The conversion factor for free flow is 3.8.
(Reference: BAM report 220, D. Lietze)

Example:

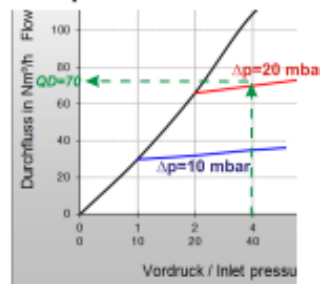

QG = QD x F

QG ▶ P = 70 x 0,9 = 63 m³/h C₃H₈

QG = flow / gas type

F = conversion factor

QD = flow / air

Certification / Technical Standards / Rules

BAM Federal Institute for Materials Research and Testing, DVGW German Technical and Scientific Association for Gas and Water, DGV German Health and Safety Regulations, DVS German Association for Welding, Cutting and Allied Processes, TRBS German Technical rules for operation safety.

Standards/ Approvals

Company certified according to ISO 9001:2015 and ISO 14001:2015, CE-marking according to: Pressure Equipment Directive 2014/68/EU

(Subject to change without notice)





15.2 DVGW certificate: Valves



Art. IK1116xx und IK1119xx



CERT

DIN-DVGW-Baumusterprüfzertifikat DIN-DVGW type examination certificate

NG-4312BN0021

Registrierungsnummer
registration number

Anwendungsbereich <i>field of application</i>	Produkte der Gasversorgung <i>products of gas supply</i>
Zertifikatinhaber <i>owner of certificate</i>	
Vertreiber <i>distributor</i>	
Produktart <i>product category</i>	Gasarmaturen: Absperrarmatur <= MOP 5 (4312)
Produktbezeichnung <i>product description</i>	Kugelhahn für die Gasinstallation
Modell <i>model</i>	LONDON; 060
Prüfberichte <i>test reports</i>	Baumusterprüfung: 11/272/4312/132 vom 02.08.2012 (EBI)
Prüfgrundlagen <i>test basis</i>	DIN EN 331 (01.08.2011)

Ablaufdatum / AZ 28.01.2017 / 11-0761-GNV
date of expiry / file no.

02.10.2012 Rie A-1'2

Datum, Bearbeiter/Büro, Leiter der Zertifizierungsstelle
date, issued by, sheet, head of certification body

DVGW CERT GmbH ist von der DAkkS nach DIN EN 45011:1998
akkreditierte Stelle für die Zertifizierung von Produkten der Energie- und
Wasserversorgung.

DVGW CERT GmbH is an accredited body by DAkkS according to EN
45011:1998 for certification of products for energy and water supply industry.



DVGW CERT GmbH
Zertifizierungsstelle

Josef-Wilmer-Str. 1-3
53123 Bonn

Tel. +49 228 91 88 - 888
Fax +49 228 91 88 - 993

www.dvgw-cert.com
info@dvgw-cert.com



A-2/2

NG-4312BN0021

Gasart gas category	Bemerkungen remarks
Brenngase nach G260	

Typ type	Technische Daten technical data	Bemerkungen remarks
066/067/068/069/266/267	Druckklasse: MOP 5/ GT 0,1 Nennweite: DN 8	
066/067/068/069/266/267	Druckklasse: MOP 5/ GT 0,1 Nennweite: DN 10	
066/067/068/069/266/267	Druckklasse: MOP 5/ GT 0,1 Nennweite: DN 15	
066/067/068/069/266/267	Druckklasse: MOP 5/ GT 0,1 Nennweite: DN 20	
066/067/068/069/266/267	Druckklasse: MOP 5/ GT 0,1 Nennweite: DN 25	
066/067/266/267	Druckklasse: MOP 5/ GT 0,1 Nennweite: DN 32	
066/067/266/267	Druckklasse: MOP 5/ GT 0,1 Nennweite: DN 40	
066/067/266/267	Druckklasse: MOP 5/ GT 0,1 Nennweite: DN 50	

Ausführungsvariante type variation	Erläuterungen explanations
066/067/068/069 060	Durchgangsform (Baureihe LONDON) Eckform; Anschlussart: beidseitig Außengewinde R 1/2 nach DIN EN 10226-1; Betätigungsorgan: Flügelgriff aus Aluminium
066	Anschlussart: beidseitig Innengewinde Rp 1/4 bis Rp 2 nach DIN EN 10226-1; Betätigungsorgan: Handhebel aus Stahl
067	Anschlussart: einerseits Innengewinde Rp 1/4 bis Rp 2, andererseits Außengewinde R 1/4 bis R 2, jeweils nach DIN EN 10226-1; Betätigungsorgan: Handhebel aus Stahl
068	Anschlussart: beidseitig Innengewinde Rp 1/4 bis Rp 1 nach DIN EN 10226-1; Betätigungsorgan: Flügelgriff aus Aluminium
069	Anschlussart: einerseits Innengewinde Rp 1/4 bis Rp 1, andererseits Außengewinde R 1/2 bis R 1, jeweils nach DIN EN 10226-1; Betätigungsorgan: Flügelgriff aus Aluminium
266	wie 066, jedoch mit flachem Handhebel
267	wie 067, jedoch mit flachem Handhebel

zertifizierte Bauteile / Werkstoffe certified components

Registr.-Nr. registration no.	Bauteil (Produktart) component	Modell/Typ model/type	Hersteller manufacturer
NG-5112AR0799	Dichtungswerkstoff aus Elastomeren für Gasgeräte und -anlagen	für 0170 NBR 70/0170 NBR 70	AR-TEX S.p.A.
NG-5146AR0617	Dichtmittel für herstellerseitig zusammengefügte Gewindeverbindungen in Gasgeräten und Komponenten	LOCTITE 2701/LOCTITE 2701	Henkel AG & Co. KGaA
DG-5112AS0532	Dichtungswerkstoff aus Elastomeren für Gasgeräte und -anlagen	für FP 70 (3170) GREEN/FP 70 (3170)	AR-TEX S.p.A.

Verwendungshinweise / Bemerkungen hints of utilization / remarks

Umgebungstemperaturbereich: -20...+60 °C

Thermische Belastbarkeit (geprüft nach DIN EN 1775, Oktober 2007): +650° C für Betriebsdrücke bis 100 mbar (GT 0,1)

SEMPERIT

GWPB

Welding/Gas - 20 bar - orange - ISO 3821 [EN 559]



SPECIFICATIONS

Application	A flexible hose for transporting liquid gas (LPG), for CNG, methylacetylene and propandiene mixes (MPS). For welding and cutting.
Standard/Approval	ISO 3821:2019 (formerly EN 559:2003).
Temperature range	-30°C / +70°C.
Safety factor	3 : 1
Tube	NBR, black, smooth.
Reinforcement	Textile spiral.
Cover	EPDM, orange, smooth.
Marking	continuous inkjet, white letters: "SEMPERIT [S] GWPB ISO 3821 [EN 559] PN 2 MPa [20 bar] ID x OD -30°C YYYY MADE IN EU // // // //".
Notice	ATTENTION: Not to be used in engine-driven vehicles. If a hose is needed for engine-driven vehicles please contact Semperit for recommendation. BS 3212-2:1991 available on request.

TECHNICAL DETAILS

Article number	Internal-Ø		Wall width mm	External-Ø mm	Work. pressure [max.] bar	Number of inserts	Bending radius [min.] mm	Weight approx. kg/m	Coil length [max.] m
	mm	inch							
68404 0435	4.0		3.5	11.0	20	2	40	0.12	50
68404 0535	5.0	3/16	3.5	12.0	20	2	40	0.13	50
68404 0630	6.3		3.0	12.3	20	2	40	0.11	50
68404 0635	6.3	1/4	3.5	13.3	20	2	40	0.14	50
68404 0830	8.0		3.0	14.0	20	2	40	0.13	50
68404 0835	8.0	5/16	3.5	15.0	20	2	40	0.18	50
68404 0930	9.0		3.0	15.0	20	2	45	0.15	50
68404 0935	9.0		3.5	16.0	20	2	45	0.20	50
68404 1035	10.0	3/8	3.5	17.0	20	2	50	0.21	50
68404 1250	12.5	1/2	5.0	22.5	20	2	65	0.36	50

Please note: Before using our products with new or untested media, or for applications that are not clearly indicated in the product information, written advice must be obtained from a specialist dealer or a Semperit application engineer. For safety reasons, all products must be inspected regularly for operational safety and replaced in the event of any damage (especially of the cover) or unusual signs of wear and tear. All products must be stored, handled, and maintained in accordance with all our respective instructions and DIN 7716:1982. The information in our catalogue as well as each individual datasheet is subject to change at any time without notice since we are constantly developing and improving our products and due to constant technical developments after the latest release date of the catalogue and/or individual datasheets. To always have the latest product and safety information make sure you visit our website (hoses.semperitgroup.com) regularly or contact one of our specialist dealers or a Semperit application engineer. All contracts concluded with us are exclusively subject to our general terms and conditions (available at semperitgroup.com). Additional important general information about the range, choice and safe use of our products can be found at our website (hoses.semperitgroup.com) and must be followed without exception.

Important notice: Our catalogue and any individual datasheet have been prepared with great care in order to provide you with all the information you need. The information contained therein is based on the state-of-



CERT

DVGW-Baumusterprüfzertifikat DVGW type examination certificate

DG-4603CR0428

Registriernummer
registration number

Anwendungsbereich <i>field of application</i>	Produkte der Gasversorgung <i>products of gas supply</i>
Vertreiber <i>distributor</i>	GOK Regler- und Armaturen GmbH & Co. KG Obenbreiter Str. 2-18, D-97340 Marktbreit
Produktart <i>product category</i>	Bauteile für die Gasinstallation: Schlauch für Flüssiggas (4603)
Produktbezeichnung <i>product description</i>	Flüssiggasschlauch mit Einlage
Modell <i>model</i>	GOK T...
Prüfberichte <i>test reports</i>	Baumusterprüfung: 157093T2/17464 vom 14.10.2016 (GWI) Ergänzungsprüfung: 157093E4/18133 vom 25.09.2021 (GWI)
Prüfgrundlagen <i>test basis</i>	DIN EN 16436-1 (01.12.2020)

Ablaufdatum / AZ 14.10.2026 / 21-0674-GNV
date of expiry / file no.

23.11.2021 Pz B-1/2

Datum, Bearbeiter, Blatt, Leiter der Zertifizierungsstelle
date, issued by, sheet, head of certification body



DVGW CERT GmbH
Zertifizierungsstelle

Josef-Wirmer-Str. 1-3
53123 Bonn

Tel. +49 228 91 88 - 888

Fax +49 228 91 88 - 993

www.dvgw-cert.com
info@dvgw-cert.com



B-2/2

DG-4603CR0428

Typ <i>type</i>	Technische Daten <i>technical data</i>	Bemerkungen <i>remarks</i>
GOK T PS 10 bar	Druckklasse: 2 max. Betriebsdruck: 10 bar	Abmessungen: 6,3 x 3,5 mm; 9,0 x 3,5 mm, 10,0 x 5,0 mm und 12,5 x 5,0 mm
GOK T PS 30 bar	Druckklasse: 3 max. Betriebsdruck: 30 bar	Abmessungen: 6,3 x 5,0 mm und 4,0 x 4,0 mm



CE 0085

DVGW

CERT

EU type examination certificate

EU-Baumusterprüfbescheinigung

CE-0085AQ0821

Product Identification No.
Produkt-Identifikationsnummer

Field of Application <i>Anwendungsbereich</i>	EU Gas Appliances Regulation (EU/2016/426) <i>EU-Gasgeräteverordnung (EU/2016/426)</i>
Owner of Certificate <i>Zertifikatinhaber</i>	GOK Regler- und Armaturen GmbH & Co. KG Oberebreiter Str. 2-18, D-97340 Marktbreit
Distributor <i>Vertreiber</i>	GOK Regler- und Armaturen GmbH & Co. KG Oberebreiter Str. 2-18, D-97340 Marktbreit
Product Category <i>Produktart</i>	Accessories for gas appliances/pressure equipment: Governor for LPG (4102)
Product description <i>Produktbezeichnung</i>	Pressure regulator for LPG, optionally with fixed or variable outlet pressure, optional with rupture safety device at the outlet side and/or manometer
Model <i>Modell</i>	M50...
Countries of Destination <i>Bestimmungsländer</i>	European Union, CH, GB, NO
Test reports <i>Prüfberichte</i>	Supplement test: B 19/12/3149 from 13.12.2019 (DBI)
Test basis <i>Prüfgrundlagen</i>	EU/2016/426 A III B (09.03.2016) DIN EN 16129 (01.08.2013) DIN 4811 (01.12.2017)

Date of Expiry / File No. 29.01.2028 / 23-0523-GER
Ablaufdatum / AZ

09.10.2023 Bd A-1/2

Date, issued by, Sheet, Head of Certification Body
Datum, Bearbeiter, Blatt, Leiter der Zertifizierungsstelle

DVGW CERT GmbH - notified by the government of the Federal Republic of
Germany and officially registered by the European Commission for conformity
assessment of gas appliances

DVGW CERT GmbH - von der Deutschen Bundesregierung benannte und von
der Europäischen Kommission offiziell registrierte Stelle für die
Konformitätsbewertung von Gasgeräten

DVGW CERT GmbH
Zertifizierungsstelle

Josef-Wirmer-Str. 1-3
53123 Bonn

Tel. +49 228 91 88 - 888
Fax +49 228 91 88 - 993

www.dvgw-cert.com
info@dvgw-cert.com



A-2/2

CE-0085AQ0821

Gas Category <i>Gasart</i>	Remarks <i>Bemerkungen</i>	
Vaporous LPG		
Type <i>Typ</i>	Technical Data <i>Technische Daten</i>	Remarks <i>Bemerkungen</i>
M50-F; M50-F/SBS	Outlet pressure: 0,35...4,0 bar Pressure rating: PS = 16 bar	with fixed outlet pressure
M50-V; M50-V/SBS	Outlet pressure: 0,35...4,0 bar Pressure rating: PS = 16 bar	with variable outlet pressure
M50-G-F; M50-G-F/SBS	Outlet pressure: 0,35...1,4 bar Pressure rating: PS = 16 bar	with fixed outlet pressure
M50-G-V; M50-G-V/SBS	Outlet pressure: 0,35...1,4 bar Pressure rating: PS = 16 bar	with variable outlet pressure
Type Variation <i>Ausführungsvariante</i>	Explanations <i>Erläuterungen</i>	
M50-F; M50G-F	fixed outlet pressure	
M50-F/SBS; ; M50G-F/SBS	fixed outlet pressure, with rupture safety device of the ST series	
M50-V; M50G-V	variable outlet pressure	
M50-V/SBS; M50G-V/SBS	variable outlet pressure, with rupture safety device of the ST series	
M50G...	pressure regulator for the second stage with fixed inlet pressure up to 4 bar	
Hints of Utilization /Remarks <i>Verwendungshinweise / Bemerkungen</i>		
ambient temperature range: -20...+50 °C		
inlet pressure range: pd +1,5 bar up to 16 bar (max. 4 bar for variations M 50G...)		
connection: at the input side G.1, G.2, G.3, G.4, G.5, G.7, G.8, G.9, G.10, G.11, G.12, G.13, G.14, G.15, G.19, G.20, G.22, G.23, G.24, G.25, G.36, G.37, G.67 according to DIN EN 16129 respectively X.1, X.2, X.3, X.4, X.5, X.6, X.7, X.8, X.9, X.10, S.11 and X.12 according to GOK-Standard		
connection: at the outlet side H.1, H.4, H.5, H.6, H.7, H.8, H.9, H.19, H.22 H.50, H.51, H.52, H.53, H.54, H.55, H.56 according to DIN EN 16129 respectively Y.1, Y.2, Y.3, Y.4 and Y.5 according to GOK-Standard		

16 Usage record

In the table below, you can document your experiences of using the flaring device.

No.	Date/ name	Location	Operating pressure	Medium	Venturi nozzle [yes/no]	Line parameters [diameter, length]	Flaring duration

Table 12: Replacement parts and accessories